



Play value

Our playscapes have been designed especially for day-care centres. They consist of individual modules which can be freely varied and combined to suit individual needs. We create exciting and diverse playscapes from platforms and different wooden boxes that can be filled with water, plants, play sand or balls. The system is complemented by sun sails which can be mounted in a number of ways.

Fundamental characteristics

- Foundations not available
- Friendly appearance
- Child-oriented dimensions according to ergonomic criteria
- The space-defining design appeals to the senses
- Numerous play offers
- Sunshade

Recommended for

- Children under 3 years
- Kindergarten children
- Supervised play areas, such as kindergartens, schools, after-school programmes or similar

The Waterbox is not suitable for children under 3 years of age

**Waterbox
Plant Box
Play Box**

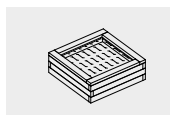

5.54010

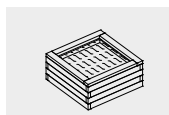

5.54015

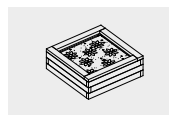

5.54020

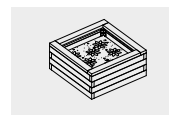

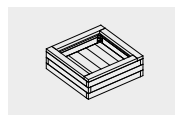

5.54025



5.54040

Order No. 5.54010 Waterbox low
Order No. 5.54020 Plant Box low
Order No. 5.54040 Play Box

Safety distance 
 Device dimensions 
 Functional distance 



Order No. 5.54015 Waterbox high
Order No. 5.54025 Plant Box high

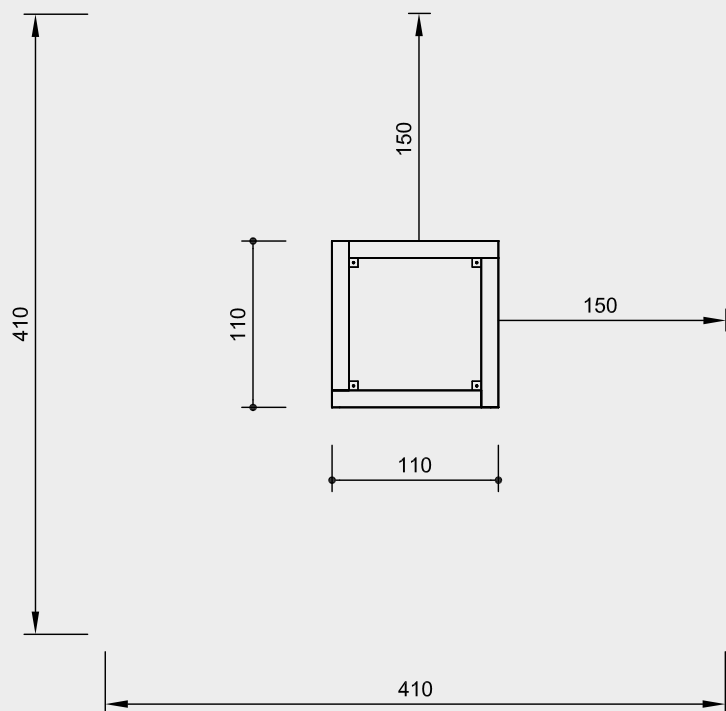

Scale 1:50

Safety check according to DIN EN 1176

Components

- 1 Play box without content
- 1 Water box with tub made of stainless steel and drain plug
- 1 Plant box with dimpled membrane (HDPE)

Installation information

Surfacing requirements corresponding to a fall height of ≤ 0.60 m (please refer to price list for more detailed information)

Foundations
 no foundations required

The surfacing should be level and firm.

Attention:
Exact measurements may vary; for all installation dimensions refer to current assembly instructions.
 Technical changes reserved.

Technical information

Equipment made of non-impregnated mountain larch

Core-free

Sawn-timbers core-free, thus decreasing occurrences of cracking and undesired changes in shape



For more detailed explanation of the quality characteristics see price list.

Order No. 5.54010 / 5.54015 Waterbox

Tub made of stainless steel incl. easy-to-close water outlet, height 10 cm

Order No. 5.54020 / 5.54025 Plant Box

Compression-proof and rot-free dimpled membrane

Dimensions

(small deviations possible)

Order No. 5.54010 Waterbox low
Order No. 5.54020 Plant Box low
Order No. 5.54040 Play Box

Height	0.40 m
Length	1.10 m
Width	1.10 m
Weight	
Order No. 5.54010	95 kg
Order No. 5.54020	65 kg
Order No. 5.54040	65 kg

Order No. 5.54015 Waterbox high
Order No. 5.54025 Plant Box high

Height	0.50 m
Length	1.10 m
Width	1.10 m
Weight	
Order No. 5.54015	110 kg
Order No. 5.54025	80 kg

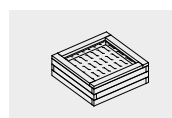

5.54010

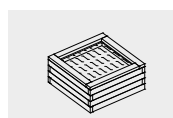

5.54015



5.54020

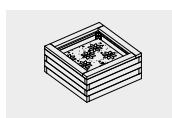

5.54025

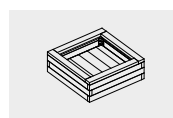

5.54040